

FAG

3308-BD-XL-2Z-TVH

Angular contact ball bearing

Schaeffler ID:
0620087570000Angular contact ball bearing 33..-BD-
XL-2Z-TVH, double row, X-life, shields,
plastic cage

X-life

Technical information

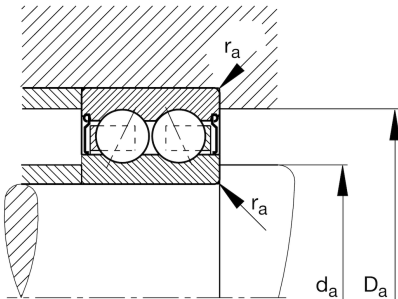
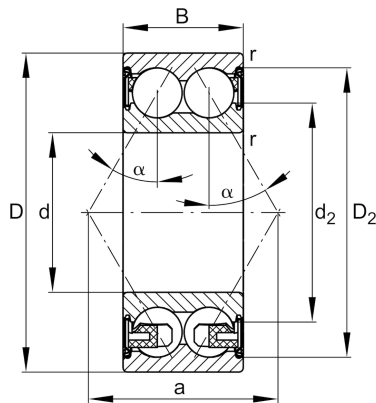
**Main Dimensions & Performance Data**

d	40 mm	Bore diameter
D	90 mm	Outside diameter
B	36.5 mm	Width
C_r	67,000 N	Basic dynamic load rating, radial
C_{0r}	48,500 N	Basic static load rating, radial
C_{ur}	3,350 N	Fatigue load limit, radial
n_G	6,000 1/min	Limiting speed
n_{gr}	7,000 1/min	Reference speed
	0.98 kg	Weight

Mounting dimensions

$d_{a \min}$	49 mm	Minimum diameter shaft shoulder
$D_{a \max}$	81 mm	Maximum diameter of housing shoulder
$r_{a \max}$	1.5 mm	Maximum fillet radius

Dimensions

r_{\min}	1.5 mm	Minimum chamfer dimension
D_2	79.9 mm	Caliber diameter outer ring
d_2	56.8 mm	Caliber diameter inner ring
a	53.1 mm	Distance between the apexes of the pressure cones
α	30 °	Contact angle

Temperature range

T_{\min}	-20 °C	Operating temperature min.
T_{\max}	120 °C	Operating temperature max.